

Cal Flame[®]

2008 OWNER'S MANUAL

Barbecue Grills

Manufactured after January 1, 2008
© 2008 Lloyds Material Supply, Inc.



CE

359BT818

Due to our continuous improvement programs, all models, operation, and/or specifications are subject to change without prior notice.

www.calspas.com

This manual applies to the following equipment:

BBQ08872U	2 burner grill
BBQ08873U	3 burner grill
BBQ08874U	4 burner grill
BBQ08874CU	4 burner convection grill
BBQ08875U	5 burner grill
BBQ08875CU	5 burner convection grill

BBQ08852U	Standard single flat side burner
BBQ08898U	Deluxe single side burner
BBQ08899U	Deluxe double side burner
BBQ08953U	Standard side by side burner
BBQ08954U	Deluxe double side by side burner

BBQ08CR2000U	Two burner cart
BBQ08CR3000U	Three burner cart
BBQ08CR3000DSU	Three burner cart with double side burner
BBQ08CR4000U	Four burner cart
BBQ08CR4000DSCU	Four burner convection cart with double side burner
BBQ08CR4000CU	Four burner convection cart
BBQ08CR5000DSCU	Five burner convection cart with double side burner

WARNING

If the information in this manual is not followed exactly, a fire or explosion may result causing property damage, personal injury or loss of life.

Do not store or use gasoline or other flammable vapors and liquids in the vicinity of this or any other appliance.

This appliance is for **OUTDOOR USE ONLY**.

Copyright 2008 Lloyds Material Supply, Inc. All rights reserved. Duplication without written consent is strictly prohibited.

Cal Spas™ and Cal Flame™ are registered trademarks.

Due to continuous improvement programs, all models, operation, and/or specifications are subject to change without prior notice.

LTR20081044, Rev. A
4/21/08

Safety Instructions 1

Installation / Assembly 3

Cabinet Cut-out Dimensions 3

Leak Testing Procedure 4

Liquid Propane Gas 4

Installing the Transformer 5

Installing Grills in Barbecue Islands 6

Installing the Rotisserie 7

Installing Side Burners 8

Operating Your Barbecue 9

Grill Controls 9

Lighting the Grill 10

Basic Grill Operation 11

Cooking with the Rotisserie 11

Cooking with a Side Burner 12

Cooking with a Convection Grill 12

Light and Fan Switch 12

Cleaning and Maintenance 13

Drip Pan 13

Care of Stainless Steel 13

Covering Your Grill 13

After Use Care 13

Light Bulb Replacement 14

Appendix 15

Troubleshooting 15

Removing and Replacing Infrared Burners . . . 17

Replacement Covers 17

Location of Serial Number Plate 18

Grill Specifications 18

Save these instructions!

CONTACT INFORMATION

For customer service, please contact your authorized dealer immediately. If you need additional information and/or assistance, please contact:

Cal Spas Customer Service Department
1462 East Ninth Street
Pomona, CA 91766.

Toll Free: 1-909-623-8781
Fax: 1-909-629-3890

www.calspas.com

Safety Instructions

WARNING: Improper installation, adjustment, alteration, service or maintenance can cause injury or property damage. Read the installation, operating and maintenance instructions thoroughly before installing or servicing this equipment.

Placement and Location

- Cal Flame™ grills are designed for outdoor use only.
- Never locate this appliance in an enclosed room, under a sealed overhead structure, or in any type of enclosed area such as a garage, shed, or breezeway. Keep clear of trees and shrubs.
- Do not place this grill under or near windows or vents that can be opened into your home.
- Cal Flame™ grills are not intended for installation in or on recreational vehicles or boats.
- Maintain sufficient distance as to not overheat any overhead combustible material such as a patio cover.
- The area surrounding your new grill should be kept clean and free from flammable liquids and other combustible materials such as mops, rags or brooms, as well as solvents, cleaning fluids, and gasoline.
- Do not use the grill, grill cabinet, or area surrounding the grill as a storage area for flammable or plastic items. Do not store liquid propane (LP) cylinders in the vicinity of this or any other appliance when it is not being used.

Set-Up

- Before installing built in grills in enclosures, copy all product information such as model number, serial number and type of fuel and store information in a safe place. This information is located on a plate located behind the grill and is visible when the hood is lowered or on the right side of the chassis. There is an area on the back cover of this manual where you can write down this information.
- Your Cal Flame™ grill must be plugged into a permanent, grounded 220V outlet with a dedicated 15A RCD breaker.
- Do not use an extension cord to supply power to your Cal Flame™ grill. Such use may result in fire, electrical shock or other personal injury. Do not install a fuse in the neutral or ground circuit. A fuse in the neutral or ground circuit may result in an electrical shock hazard. Do not ground this appliance to a gas supply pipe or hot water pipe. Keep any electri-

Read all instructions before you operate your grill.

cal supply cords and the fuel supply hose away from any heated surfaces.

- To prevent fire and smoke damage, remove all packaging material before operating grill.
- Before you start cooking, clean the entire grill thoroughly with hot, soapy water. This is necessary to remove residual solvents, oil and grease used in the manufacturing process. The grates should also be thoroughly cleaned in the same manner.

Operation

- Do not use grill for other than intended use.
- In the event that a burner goes out, turn burner knobs to the full OFF position, fully open the grill hood and let it air out. Do not attempt to use the grill until the gas has had time to dissipate.
- Never use the grill if the drip pan is not properly installed. Drip pan should be pushed all the way to the rack located just under the grill. Fire or explosion can result from an improperly installed drip pan.
- Keep all electrical supply cords and the rotisserie motor cord away from the heated areas of the grill.

DANGER

What To Do If You Smell Gas

- Shut off gas to the appliance.
- Extinguish any open flame.
- Open lid.
- If odor continues, keep away from the appliance and immediately call your gas supplier or your fire department.

Safety Instructions

- Never use the grill or side burner in windy conditions. If used in a consistently windy area a windbreak will be required. Always adhere to the specified clearances listed in this manual.
- Never line the grill or side burners with aluminum foil.
- Do not install or operate your grill unit in such a manner that the cross ventilation openings are blocked. Fresh air must be able to pass through installed vents to safeguard against residual gas accumulation. Failure to allow proper ventilation may cause fire or explosion.
- When handling gas line and connectors, do not allow them to come in contact with any metal surfaces of the grill or cabinet. Do not drop connectors.
- Do not use fuel such as charcoal briquettes in gas grills.
- Gas sources to the grill and side burners must be regulated. Do not operate grill or side burners if regulators have been removed, fire or explosion can occur.
- Never leave the grill and side burners unattended when in use. When using pots and pans, boil-overs will cause smoking and greasy boil-overs may ignite.
- Do not use water on grease fires. Never pick up a flaming pan. Turn the appliance off and smother the flaming pan with a tight-fitting lid, a cookie sheet or a flat tray. For flaming grease outside of the pan, smother it with baking soda or use a dry chemical or foam-type fire extinguisher.
- Never allow clothing, pot holders or other flammable materials come in contact with or be close to any grate, burner or hot surface until it has fully cooled. Never wear loose fitting or hanging garments while using your grill. Fabric may ignite and result in personal injury.
- When using the grill, do not touch the grill rack, burner grate, or immediate surroundings as these areas become extremely hot and can cause burns. Use handles or knobs.
- Only use dry pot holders and do not use a towel or other bulky cloth in place of pot holders. Moist or damp pot holders used on hot surfaces can cause burns.
- Do not heat any unopened glass or metal container of food on the grill. Pressure may build up and cause the container to burst, possibly resulting in serious personal injury or damage to the grill.
- Do not reach over your grill or any other surfaces when hot or in use.

Maintenance and Repair

- Spiders and other insects can nest in the burners of the grill and block the gas and airflow to the burner ports. This creates a dangerous condition that can result in a fire behind the valve panel. Inspect and clean the burners periodically and follow the guidelines in the Cleaning and Maintenance section of this manual.
- Unless specifically recommended in this manual, do not repair or replace any part of the grill. A qualified technician should perform all service. Any repairs made by a non-Cal Flame approved dealer technician will void your warranty.

Storage

- When your gas grill is not in use, turn off the gas at the supply valve.
- Storage of a grill indoors is permissible only if the gas supply is disconnected.

Precautions Regarding Children

- Never leave children unattended in the area where the grill is being used. Close supervision of children is necessary when any appliance is used near children.
- Do not store items of interest to children around or below the grill.
- Never allow children to sit or stand on any part of the grill.

Installation / Assembly

Most cities and counties require permits for exterior construction and electrical circuits. In addition, some communities have codes requiring residential barriers such as fencing and/or self-closing gates on property to prevent unsupervised access to the property by children under the age of five. Your dealer can provide information on which permits may be required and how to obtain them prior to the delivery of your equipment.

We recommend the installation, adjustment and service of your new grill be performed by qualified installers and service technicians to ensure proper operation and prevent accidents.

When planning your Cal Flame™ grill location, access to gas lines and power source should be considered. The location with the shortest gas line run is recommended. A grounded, dedicated, 220V 15A RCD power source is required for use of your appliances.

When determining a suitable location, consider factors such as exposure to wind, proximity to traffic paths, and windows that open into the home.

Locate barbecue grills only in well-ventilated areas and only on solid, flat foundations (e.g. deck or cement slab).

IMPORTANT: Cal Flame™ grills are manufactured to operate on liquid propane (LP) gas and cannot be converted. To verify the grill's operating fuel, check the serial number label in the back of the chassis as you are looking at the grill from the front. LP will be marked on the operating tab, indicating the proper operating fuel. Attempting to convert Cal Flame™ grills from one fuel to another may result in serious injury and will void the warranty coverage.

Always check the rating plate to make sure the gas supply you are hooking up to is the gas type the grill is manufactured for.

Cabinet Cut-out Dimensions

Your Cal Flame™ grill is designed for easy installation into a non-combustible enclosure. The supporting deck or counter must be flat and level. When determining the final location of your grill, adequate cross ventilation must be present to prevent gas from being trapped in the event of a leak.

The drawings at right shows the cabinet cut-out dimensions for gas grills and the side burner.

Model Number	Description	Width	Depth	Height
BBQ08872U	2 Burner Grill	59.1 cm	59.1 cm	23.5 cm
BBQ08873U	3 Burner Grill	59.1 cm	59.1 cm	23.5 cm
BBQ08874CU	4 Burner Grill	78.1 cm	56.5 cm	23.5 cm
BBQ08875CU	5 Burner Grill	97.2 cm	56.5 cm	23.5 cm
BBQ08898U	Deluxe Single Side Burner	30.8 cm	55.2 cm	18.4 cm
BBQ08899U	Deluxe Double Side Burner	31.5 cm	55.3 cm	18.4 cm

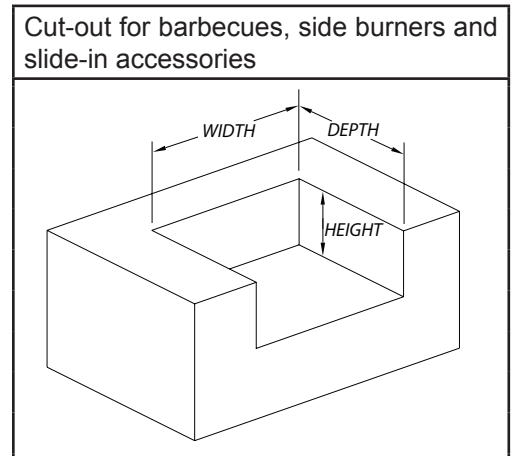

Installation / Assembly

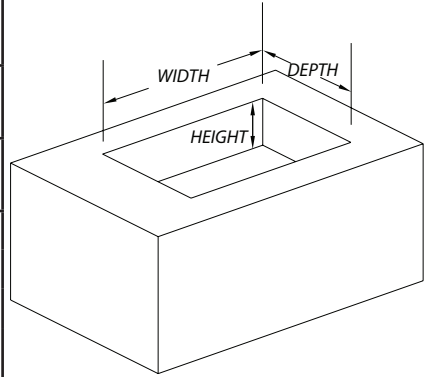
Model Number	Description	Width	Depth	Height	Cut-out for drop in accessories
BBQ08852U	Drop In Standard Side Burner	29.2 cm	45.1 cm	7.0 cm	
BBQ08953U	Standard Side by Side Burner	61.6 cm	50.2 cm	10.8 cm	
BBQ08954U	Deluxe Side by Side Burner	64.1 cm	33.7cm	18.4 cm	

Leak Testing Procedure

Perform a leak test at least once a year whether the gas supply has been disconnected or not. In addition, whenever the gas supply is connected to the regulator or whenever any part of the gas system is disconnected or replaced, perform a leak test.

As a safety precaution, remember to always leak test your grill outdoors in a well-ventilated area. Never smoke or permit sources of ignition in the area while doing a leak test. Do not use a flame, such as a lighted match to test for leaks. Use a solution of soapy water.

1. Prepare a leak testing solution of soapy water by mixing in a spray bottle one part liquid soap to one part water.
2. Make sure all the control knobs are in the OFF position.
3. Turn on the gas. Turn the gas supply valve counter clockwise one turn to open.
4. Apply the leak-testing solution by spraying it on joints of the gas delivery system. Blowing bubbles in the soap solution indicates that a leak is present.
5. Stop a leak by tightening the loose joint or by replacing the faulty part with a replacement part recommended by the manufacturer.
6. Turn all control knobs back to the full OFF position.

If you are unable to stop a leak:

1. Turn all control knobs back to the full OFF position.
2. Shut off the gas supply to the grill and release pressure in the hose and manifold by pushing in and turning any of the control valves one quarter turn counter-clockwise.
3. Call an authorized gas appliance service technician.

Do not use the appliance until the leak is corrected.

Liquid Propane Gas

Tank Requirements

For plumbed-in LP installation, use a convertible regulator and set it for LP gas.

Maximum line pressure for plumbed-in propane is 14" WC (3.5 kPa). Minimum line pressure for propane is 11" WC.

The grill unit must be used with the gas pressure regulator. The regulator will control and maintain a uniform gas pressure in the manifold. The burner orifices have been sized for the gas pressure delivered by the regulator.

WARNING: Attempting to operate the grill unit without the gas regulator installed could cause an explosion and possible death.

LP Gas Hook Up

An enclosure for an LP gas cylinder shall be vented by openings at the level of the cylinder valve and at floor level. The effectiveness of the openings for purposes of ventilation shall be determined with the LP-gas supply cylinder in place. This shall be accomplished in one of the following manners:

1. One side of the enclosure shall be completely open.
2. Enclosures that have four sides, complete with a top and bottom:
 - a. At least two ventilation openings at cylinder valve level shall be provided in the sidewall, equally sized, spaced at 180° (3.14 rad), and unobstructed. Each opening shall have a total free area of not less than 7.1 cm²/kg (one square inch per pound) of stored fuel capacity, and not less than a total free area of 64.5 cm² (10 square inches).
 - b. Ventilation openings shall be provided at floor level and shall have a total free area of not less than 7.1 cm²/kg (one square inch per pound) of stored fuel capacity and not less than a to-

tal free area of 64.5cm² (10 square inches). If ventilation openings at floor level are in a side-wall, there shall be at least two openings. The bottom of the openings shall be at floor level and the upper edge no more than 127 mm (5 inches) above the floor. The openings shall be equally sized, spaced at 180° (3.14 rad) and unobstructed.

- c. Every opening shall have minimum dimensions so as to permit the entrance of a 3.2 mm (1/8 inch) diameter rod.

Transporting and Storing LP Gas

Transport only one cylinder at a time. Ensure the cylinder is secured in an upright position with the control valve turned off and the dust cap in place. Store cylinders outdoors and out of reach of children. Do not store cylinders in a building, garage, or any other enclosed area.

Installing the Transformer

All grills with electrical components such as lights or a convection fan will require the transformer to be installed and plugged in before you can use it. This needs to be done **before** the grill is inserted in the barbecue island. When the transformer is attached to the grill chassis, use care in placing the grill in the island cutout to avoid hitting the transformer.

Installation / Assembly

1. Remove the transformer and the metal screws from the plastic bag.
2. Place the grill on a sturdy surface and tilt it back to show the underside of the grill.
3. Using the metal screws, attach the transformer to the left side of the grill near the internal electrical connection. Attach the metal plate to the outside surface of the grill as shown in the figure below.
4. When you have firmly tightened the screws and nuts, connect the plug from the transformer to the grill. Screw on the stainless steel retainer.

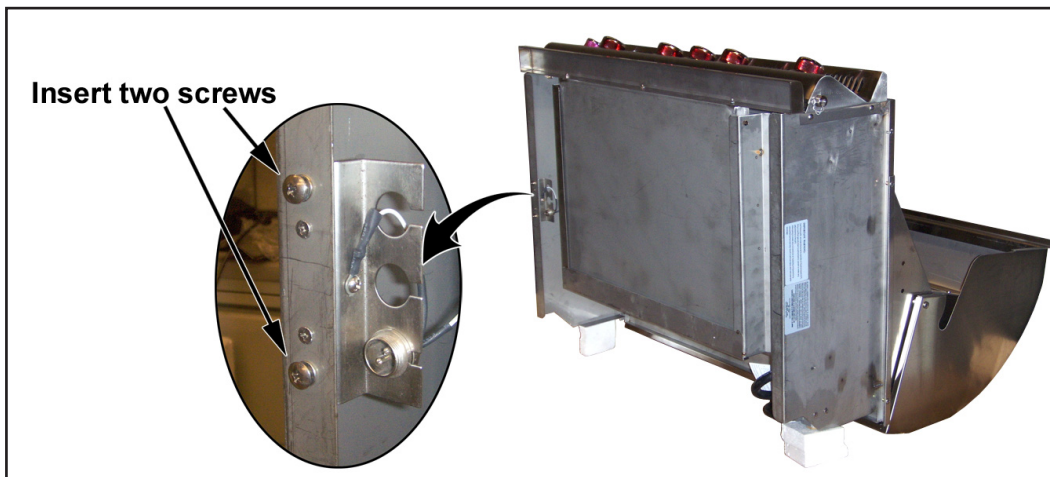

Installing Grills in Barbecue Islands

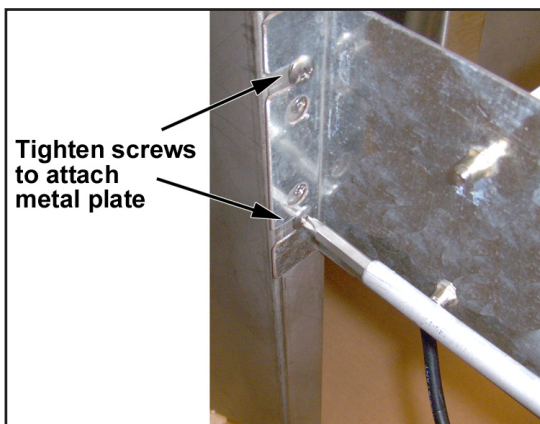

You will need a second person to help you to avoid damaging the grill, the transformer, or your barbecue island.

Before installing a grill or side burner in any island or cut out, make sure that the opening is not bigger than the outside frame of the grill unit. The grill should rest on the lip of the frame. For drop-in accessories, adequate cross ventilation must be designed into enclosure to ensure the drop-in grill or side burner does not become overheated.

Pay careful attention to the location of gas lines. Gas lines should be routed away from sources of heat and should make as few bends as possible.

Check to see if gas line connections will be accessible when grill is installed.

- If gas line connections are not easily accessible when the grill is installed, support the grill above counter level and attach the gas lines to the grill. When the gas connections are made, slide the grill into the cut out.
- If gas line connections are accessible when the grill is installed, slide the grill into the cut out and then attach the gas lines.

Be very careful not to kink gas lines when lowering the grill or side burner into the cut out.

Keep your fingers away from where the grill will be supported on counter. Your fingers could become trapped and serious injury could occur.

Check to make sure the grill is level and is supported around the entire outside edge. If the grill is not level or is unstable, use non-combustible shims under the outside lip to stabilize it.

Perform the leak test procedure as described earlier in this manual.

Installing the Rotisserie

Attach the two brackets to the sides of the grill, one on each side, using two screws as shown below.

Slide the rotis motor on one of the brackets as shown below. The rotis motor will work on either side of the grill.

Remove the metal cap protecting the outlet that provides

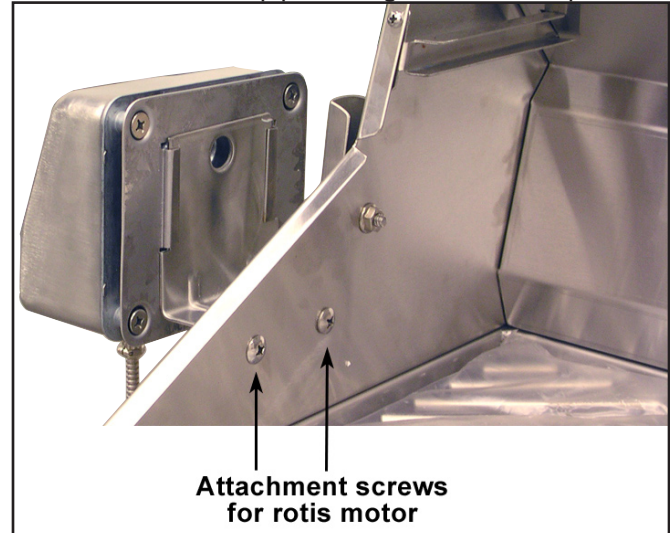

power for the rotis motor. Plug in the motor cord and screw on the retainer nut to keep the plug in place.



Installing Side Burners

1. Assemble a 9.5 mm pipe nipple to the 9.5 mm pipe tee using Teflon tape or pipe sealant. Use only sealant that is approved for use on LP gas.
2. Install the pipe tee assembly to the grill intake pipe. Tighten assembly and align the branch opening of the tee with the hole of the cabinet.
3. Connect the flexible hose (male end) to the pipe tee.
4. Install and secure the side burner into the island by simply setting it in place.
5. Connect the female end of the flexible hose to the side burner intake pipe.
6. Connect gas supply to the grill.
7. Check for gas leaks using soap water solution.

Items included with barbecue

- 1) One 9.5 mm "T" adapter
- 2) Two 9.5 mm hose fittings

Regulator is NOT included with barbecue.

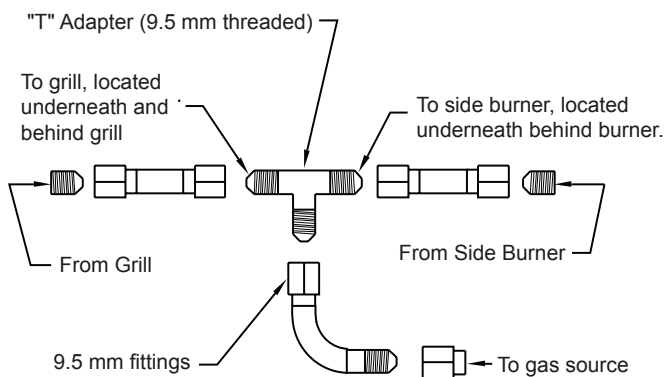

NOTE: You will need to use a gas rated sealer on gas connectors that are not flared.

- (A) Open barbecue door. Install flexible hose with regulator to gas source, then connect other end to "T" adapter. Make sure to use gas rated tape seal when installing adapter to insure proper seal.

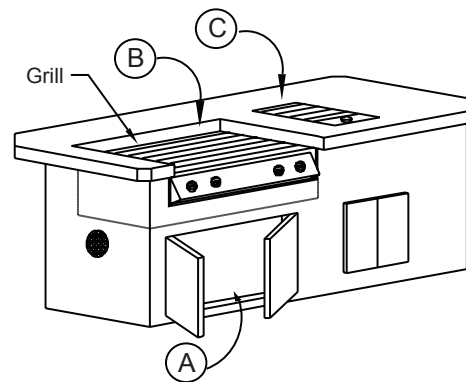

- (B) Take the other end of "T" adapter with flexible hose attached and connect to end of male fitting located underneath and at the back of the grill. (Use gas rated tape seal on all connections).
- (C) Connect the last open line to the side burner. (Use gas rated tape seal on all connections)

Operating Your Barbecue

Read all instructions before you operate your grill.

Cal Flame grills are for outdoor use ONLY.

We recommend you wash your entire grill with soap and water prior to lighting it for the first time. Oils are used during the manufacturing process and some residual oil may still be on the stainless steel parts of your grill. Washing will reduce the possibility of discoloration. We also recommend you keep your grill covered when not in use. This will minimize the amount of dust and dirt that accumulates on your grill and extend the life of your grill.

Remember to use your Cal Flame grill safely by following these reminders:

- It is dangerous to use barbecue grills and side burners in any manner other than for what it is designed for.
- Do not use charcoal in a gas grill or side burner or electric grill.
- Do not heat sealed containers such as cans or jars on grills or side burners. Explosion may result resulting in injury or death. Any sealed container, such as a pressure cooker, must have a properly operating pressure relieve valve to minimize explosion hazard.
- Never put combustible material such as paper, cloth, or flammable liquids on your grill at any time. Do not use grill, side shelves, cabinets, or any area around grill to store flammable materials.
- Never operate main burners and rear infrared convection burners at the same time. Excessive grill temperatures will result. Never allow your grill temperatures to exceed 260°C (500°F).

Grill Controls

The controls shown at right are for Cal Flame™ drop-in grills. Familiarize yourself with these controls before using your Cal Flame™ barbecue.

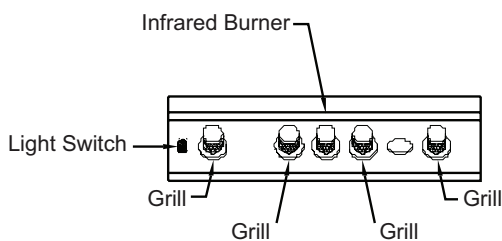
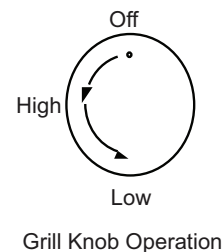

BBQ07874CPE - 4 Burner Grill

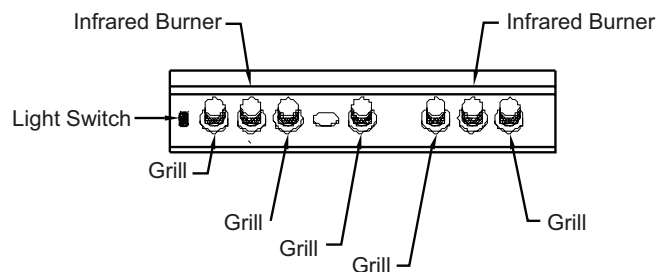

BBQ07875CPE - 5 Burner Grill

Warning

NEVER cover the entire cooking or grill surface with griddles or pans. Overheating will occur and burners will not perform properly when combustion heat is trapped below the cooking surface.

CAUTION: NEVER spray water on a hot gas unit. This may damage porcelain or cast iron components.

Lighting the Grill

Each time you light the grill, check the following:

- Inspect the hose before using the grill. If there is excessive abrasion or wear, or if the hose is cut, it must be replaced prior to using the grill. If you need a replacement hose, contact your Cal Flame dealer.
- Ensure the area around the barbecue is clear of flammable substances such as gasoline, yard debris, wood, etc.
- Ensure there is no blockage of the airflow through the vent space located below the face of the unit.
- Ensure the burner flames burn evenly along both sides of each burner with a steady flame (mostly blue with yellow tipping). If burner flames are not normal, check the orifice and burner for insects or insect nests.
- Ensure the in-line gas valve is always shut OFF when the barbecue is not in use.
- Do not operate the side burner with its cover closed or the back burner with its cover installed.

Electronically Lighting the Grill and Infrared Burners

1. Open the hood.
2. Keep your face as far away from the burners as possible.
3. Rapidly rotate the burner knob counter clockwise past the light position to HIGH. You will hear a loud click as the electronic lighter produces a spark.
4. Listen for the sound of the gas igniting. If the burner does not light on the first try, repeat immediately.
5. If the burner does not light after three attempts, turn the control knobs to the OFF position. Wait five minutes until the gas clears before attempting to light it again.
6. Repeat the procedure or try the manual lighting procedure below.
7. Upon successful lighting, repeat the process on the other burners you wish to light.
8. To shut off the burners, rotate the knob and turn to OFF. It is normal to hear a popping sound when the burners are turned off.

Manually Lighting the Grill and Infrared Burners

WARNING: Do not use standard matches or cigarette lighters to perform match lighting procedures. Serious burns can occur and lighters can explode.

1. Open the hood.
2. If you have just attempted to light the burner, allow five minutes for any accumulated gas to dissipate.
3. Slide out the drip tray from the grill.
4. Keep your face as far away from the burners as possible.
5. Light and insert a long stem match, holding it near the burner ports.
6. Push in and turn the control knob just past the LIGHT position to HIGH.
7. Listen for the sound of the gas igniting. If the burner does not light after five seconds, turn the control knobs to the OFF position. Wait five minutes until the gas clears before attempting to light it again.
8. If the burner does not light after several attempts see Troubleshooting Guide in the back of this manual.

Basic Grill Operation

Before lighting, make sure all burner controls are off. Do not attempt to light the burners if the smell of gas is present. Check the connection with a soap and water solution after attaching the hose. Make sure there is gas in the tank and it is sitting upright.

1. Make sure the drip tray is in place.
2. Light the grill burners using the instructions on the previous page.

3. Turn the control knob to HIGH and preheat the grill for 15 minutes. Close the top cover during the appliance preheat period.
4. Place the food on the grill and cook to desired completion. Adjust heat setting if necessary. You may set the control knob to any position between HIGH and LOW.
5. Allow the grill to cool and clean the drip tray after each use.

Do not leave the grill unattended while cooking.

Cooking with the Rotisserie

The rotisserie burner is an infrared type, which provides intense searing radiant heat. It is designed to cook items from the back using infrared heat. The location of the burner allows the placement of a rotisserie-basting pan (NOT included) beneath the food to collect juices and drippings for basting and gravy.

The rotisserie does not require an additional outlet as it is powered by a 12-volt input located on the side of the grill connected with a stainless steel sheathed power cable.

1. To load the rotisserie rod, hold the handle firmly while sliding one of the fork assemblies (prongs facing away from the handle) onto the rod. Push the rod through the center of the food, then slide the other holder (prongs toward the food) onto the rod. Center the meat on the rod and push the fork assemblies firmly together. Tighten the thumbscrews. To secure any loose portions of your meat, use butcher string (never use nylon or plastic string). Place a basting pan under the food to collect the drippings.

2. To use the rotisserie, first mount the motor on the left side of the grill. Place securely onto support bracket.
3. The rod of the rotisserie system is assembled into the motor by placing the pointed end into the motor and resting the threaded end on the support at the side of the grill. Once the rod is pushed as far as possible into the motor, the grooved end of the rod should rest on the right side bracket.
4. If necessary, to offset unbalanced loads, slide the counter weight on to the rod. With the counter weight loose, allow the loaded rod to rotate and come to a stop. Now rotate the counter weight above the rod in a vertical position and tighten the thumbscrew. You can slide the counter weight away from or closer to the rotisserie rod as needed for balanced operation. Once lit, the rotisserie burner will reach cooking temperature in about one minute. The orange/red glow will even out in about five minutes.

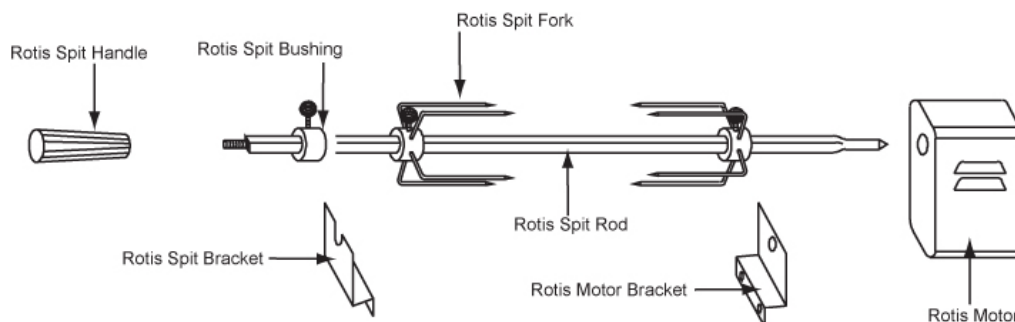

Operating Your Barbecue

Cooking with a Side Burner

Always use the proper size pan. Pans should be no smaller than 12.5 cm (5 inches) and no larger than 28 cm (11 inches). Select utensils with flat bottoms large enough to cover the burner. The use of under-sized utensils exposes the sides of the utensils to direct contact with a portion of the flame. This can scorch utensils and hamper cleanup. Excessive flames on large stainless steel pots can result in permanent discoloration. For best results, we recommend commercial quality aluminum pans and utensils.

Never leave the grill and side burners unattended when in use. When using pots and pans, boil-overs will cause smoking and greasy boil-overs may ignite.

Always position handles of utensils so they do not extend over adjacent work areas or cooking areas. This reduces the risk of burns, ignition of flammable materials, and spillage due to accidental contact with the utensils.

Cooking with a Convection Grill

A convection grill has an internal fan that circulates heated air evenly throughout the grilling area when the hood is closed. Cooking in this way distributes heat more efficiently so you no longer have to be concerned with “hot spots” on the grill where food tends to burn. The fan switch is located at the far left of the front panel of the grill.

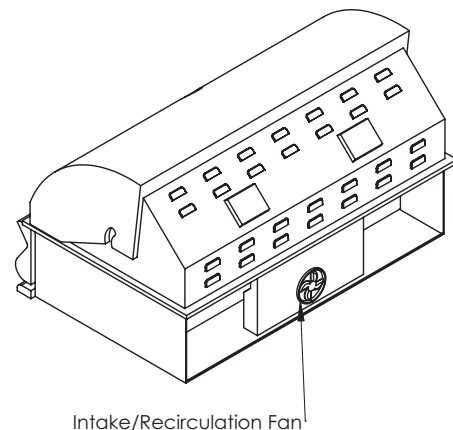
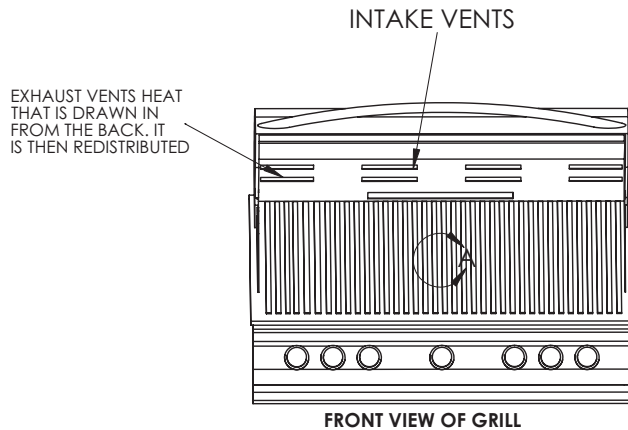

Light and Fan Switch

The ON / OFF switch controlling your halogen light is located at the control panel on the front lower left side.

Certain models of the Cal Flame grill are equipped with either one or two halogen light.

Your grill must be plugged into a permanent grounded 220 VAC outlet with a dedicated 15A RCD breaker. DO NOT cut or remove the ground prong as this may result in fire, electrical shock or other personal injury. This electrical source provides power to the lights.



Cleaning and Maintenance

Clean internal parts of the grill regularly as determined by the amount of use and foods cooked. The entire grill should be cleaned at least once a year.

In addition, keep the area around your grill clear and free from combustible materials, gasoline, and other

flammable vapors and liquids. Do not obstruct the flow of combustion and ventilation air.

DISCONNECT ELECTRICAL SUPPLY BEFORE CLEANING ANY PART OF THE GRILL.

Burners

Spiders and small insects occasionally inhabit or make nests in the burner tubes, obstructing the gas flow. Sometimes this results in a type of fire in and around the gas tubes called "flashback". To reduce the risk of flashback, this procedure should be followed at least once a month or when your grill has not been used for an extended period of time.

IMPORTANT: Prior to starting this procedure, turn OFF all of the gas control knobs, shut off the fuel supply, and disconnect the fuel line.

1. Remove burners from the grill by carefully lifting each burner up and away from the gas valve orifice.
2. Use a wire brush to clean the outer surface of each burner to remove food residue and dirt. Clean any clogged ports with a stiff wire such as an opened paper clip.
3. Inspect each burner for damage (cracks and holes). If any damage is found, replace the burner and discontinue grill usage.
4. Upon reinstallation, inspect the gas valve orifices for cleanliness and condition and the location of the igniters.

Drip Pan

The full width drip pan will collect grease from the main grill area. The pan should be cleaned after every use to avoid the possibility of a grease fire. Be sure to allow the drip pan to cool prior to cleaning. You may clean the drip pan with a solution of warm soapy water. Make sure to rinse thoroughly to avoid staining.

Care of Stainless Steel

Do NOT use wire wool pads, scrapers, harsh abrasive, scoring materials, bleaches, or harsh cleaners on your grill or allow salt and vinegar mixtures to remain in contact for a long period of time. This will cause scratching, scoring, rusting and pitting.

We recommend that you clean stainless steel components with a cleaner that is approved for stainless steel and only clean when the grill is cool and in indirect light. Never use steel wool.

Covering Your Grill

When not in use and after cooling, cover your grill with our full length, zippered side canvas cover. (See your local Cal Flame dealer for details.) The cover will help protect your grill from detrimental effects of weather and environmental pollutants. Never put a cover on a hot grill. Allow the grill to cool before covering.

After Use Care

The easiest way to clean the grill is immediately after cooking is completed and after turning off the flame.

- Scrub the grill rack with a brass bristle barbecue brush and hot soapy water.
- Wipe the grill with a damp soapy cloth and rinse with warm/hot, clean water. For more tenacious deposits, including oil, grease and water-borne deposits, use a multipurpose cream cleanser and apply with a soft, damp cloth.
- Dry with a soft, dry, clean towel if preferred.

Cleaning and Maintenance

Light Bulb Replacement

WARNING: Never attempt to replace a light bulb when the grill is in use. Serious burns will result.

WARNING: Never touch halogen bulbs with your bare fingers. Use a tissue or a small piece of paper to handle bulbs. Oils from your hands will damage halogen bulbs.

Light Removal

1. Open the grill hood and locate the glass light covers at the back of the grill.
2. Using a small screwdriver, gently pry the light cover away from the housing. *Be extremely careful prying off the light cover.* You may damage the light cover as a result.
3. Unscrew the two screws located at the side of the white ceramic light fixture.
4. Pull the burnt bulb out of the socket.

Light Replacement

1. Using a tissue or small piece of paper, carefully push a new bulb into the socket, making sure both wires on the bulb go into the light socket evenly.
2. Tighten the two screws on the side white ceramic light fixture.
3. Carefully replace the light cover by snapping it in place.

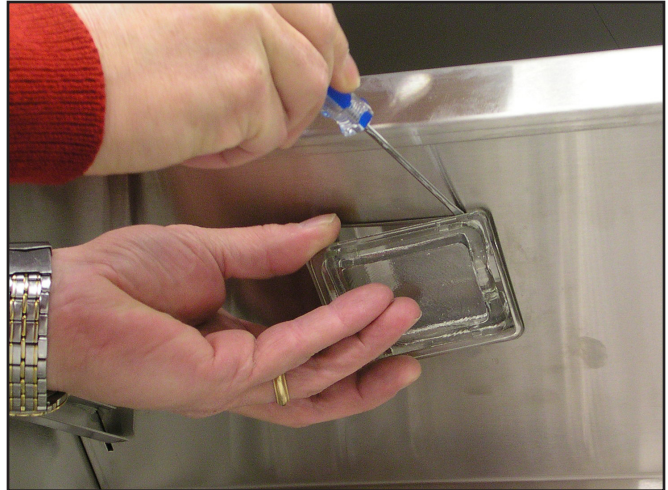

Troubleshooting

Problem: Smell of gas is present

Solution: Check for loose connections in the gas line. Perform a leak test following the procedure described in this manual.

Problem Burner does not ignite

Solution Use the following procedure with the figure below.

Check the position of the sparker tip. It should be pointing forward towards the front of the burner.

- Make sure there is a blue spark at the electrode tip to the burner.
- Make sure the igniter wire is connected firmly to the valve ignition device and the electrode.
- Make sure the valve orifice is free of any debris, dust or grease.
- Make sure the valve orifice is aligned inside the front hole of the burner.
- If there is no spark at all, replace the electrode or igniter wire.

Note: Turn off the gas at the source while troubleshooting.

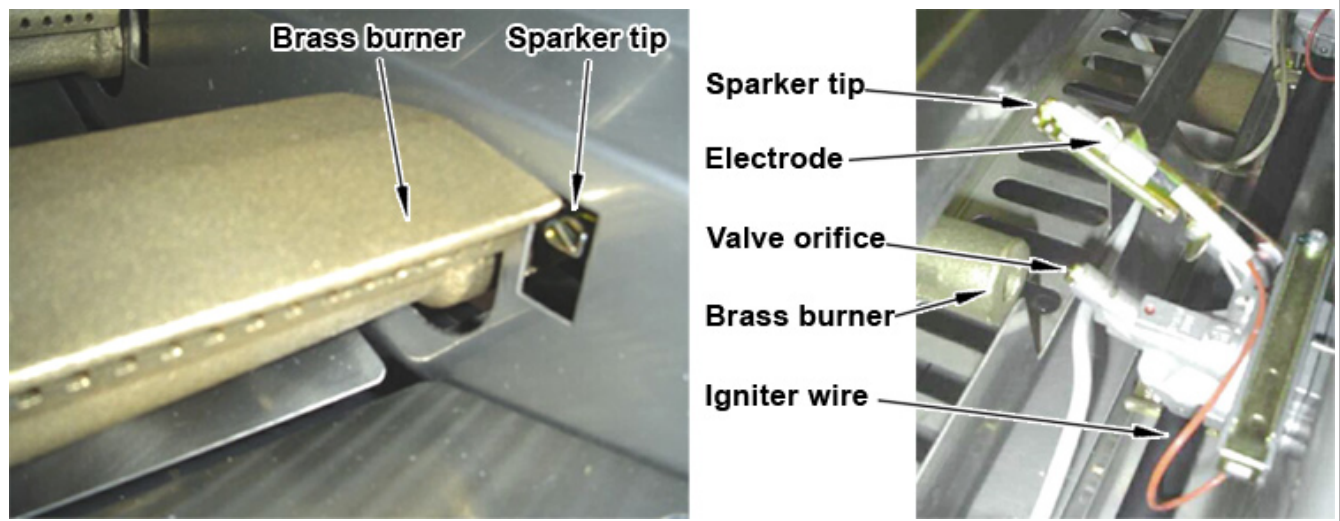

Problem: Burner tube is misaligned over the orifice

Solution: Reposition the burner tube so that it is properly seated over the orifice.

Problem: Obstruction in the gas line

Solution: Remove the fuel line from grill. (Do not smoke or perform any maintenance in the vicinity of an open flame.) Open the gas valve for one second to blow out any debris. Close off the gas valve and reconnect the fuel line securely.

Problem: Yellow Flame

Solution: Once the entire burner is operating, check the flame color to be sure that it is mostly blue. Some yellow at the tips may be present due to impurities in the fuel. If the flame is golden or yellow in color, the reason could be seasoning salts, oil film, or other foreign matter on the burner.

Appendix

Problem: Plugged orifice

Solution: Unplug the orifice as follows:

- Remove cooking grills, flame tamer and grease tray.
- Remove burners from the bottom of the firebox by pulling the cotter pin from beneath the burner peg using a standard screwdriver or needle nose pliers.
- Carefully lift each burner up and away from the gas orifice.
- Remove the orifice from the control valve.
- Gently clear any obstruction with a fine wire.
- Reinstall the orifice, reinstall the burners over the orifices, and seat each burner peg into position hole at the bottom ledge of the firebox.
- Replace all cotter pins.
- Replace cooking components and grease collectors.

If an obstruction is suspected in the control valve, contact your local Cal Flame dealer for assistance.

Problem: Misalignment of Igniter on Burner

- Solution:**
- Check for proper position of the electrode tip, which should be pointing forward towards the front of the burner and free of grease to allow proper sparking.
 - The ignition wire should be connected firmly to the valve ignition device and electrode. Replace the ignition wire if it is frayed or cracked.
 - With the gas supply closed and all control knobs set to the off position, check each position igniter individually for the presence of a spark at the electrode. Push each knob in fully and rotate it about 1/4 turn to the left (counter-clockwise) until you hear a loud click. The trigger hitting the strike block should produce a blue spark at the electrode tip. Return control knob to the off position before checking the next igniter.
 - While the grill is still hot, wait for a minimum of five minutes before commencing re-ignition. (This allows accumulated gas fumes to clear.) If all checks / corrections have been made and the gas grill still fails to operate properly, contact your local Cal Flame dealer.

Problem: Flashback

Solution: When fire occurs in and around the burner tubes, immediately turn off gas at its source and turn the control knob clockwise to the 'OFF' position. Wait until the grill has cooled off and then clean the burner tubes and burners as described on page of this manual.

Removing and Replacing Infrared Burners

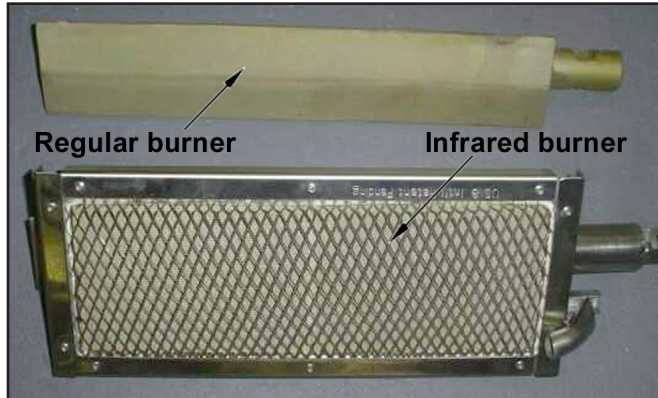

1. Disconnect or shut off the gas line connect to the grill. Wait until the burners cool down.
2. Open the hood and remove the grate and flame tamer on top of the burner you want to replace.
3. Through the access door underneath the grill, find the round stud and locking pin that locks the burner in place.

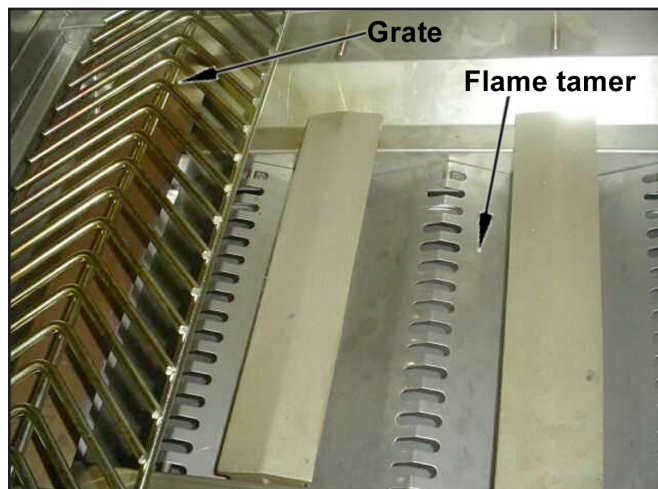

4. Carefully remove the locking pin with your fingers.



5. Raise the stud from the locking hole and move the burner forward carefully to release it from the ignition and gas supply valve.
6. Take the burner out of the grill and store it in a safe and dry place.
7. Install the infrared burner. Align the gas inlet on the burner with the gas supply valve on the grill and torch tube with ignition. Make sure they align perfectly. Slide the stud at the other end into the locking hole.
8. Adjust the infrared burner. Make sure the burner is aligned and in position.
9. Install the locking pin. Through the access door underneath the grill, find the stud to lock the burner in place. Install the locking pin. Make sure the locking pin is secured correctly.
10. Repeat steps 2 through 9 if you want to replace other burners.
11. Put back the grate you just removed. (You don't need the flame tamer for infrared burners.)
12. Reconnect or turn on the gas line.

If you want to change back to regular burners, just follow the procedure above in reverse order.

Replacement Covers

2 burner / 3 burner grill	CVRBLT001	5 burner with deluxe 2 side burner	CVRCRT036
4 burner grill	CVRBLT003	Standard single flat side burner	CVRSBR050
5 burner grill	CVRBLT007	Standard side by side flat burner	CVRSBR052
2 burner / 3 burner cart	CVRCRT030	Deluxe double side burner	CVRSBR054
4 burner cart	CVRCRT032	Deluxe double side by side burner	CVRSBR056

Grill Specifications

Electrical supply: 220V AC / 50 Hz

Country of destination	BE, CY, CZ, EE, FR, GR, IE, IT, LV, LT, LU, PT, RO, SK, ES, CH, BG	AT, HU, SK, CH, DE
Gas category	I3+ (28-30/37)	I3 b/p (50)
Gas and supply pressure	G30 / 28-30/37 MBAR	G30 / 50 MBAR

BBQ08872U	2 burner grill	8.78 kWh
BBQ08873U	3 burner grill	16.4 kWh
BBQ08874U	4 burner grill	21.9 kWh
BBQ08874CU	4 burner convection grill	21.9 kWh
BBQ08875U	5 burner grill	28.4 kWh
BBQ08875CU	5 burner convection grill	28.4 kWh
BBQ08852U	Standard single flat side burner	4.4 kWh
BBQ08898U	Deluxe single side burner	4.4 kWh
BBQ08899U	Deluxe double side burner	8.78 kWh
BBQ08953U	Standard side by side burner	8.78 kWh
BBQ08954U	Deluxe double side by side burner	8.78 kWh
BBQ08CR2000U	Two burner cart	8.78 kWh
BBQ08CR3000U	Three burner cart	16.4 kWh
BBQ08CR3000DSU	Three burner cart with double side burner	25.18 kWh
BBQ08CR4000U	Four burner cart	21.9 kWh
BBQ08CR4000DSCU	Four burner convection cart with double side burner	30.68 kWh
BBQ08CR4000CU	Four burner convection cart	21.9 kWh
BBQ08CR5000DSCU	Five burner convection cart with double side burner	37.18 kWh

Location of Serial Number Plate

The serial number of your Cal Flame grill is located on the back and is visible when the hood is down as shown at right.

